



INSTALLATION MANUAL

Indoor Unit
AQB18J6WC
AQB24J2WC

Outdoor Unit
UQB18J6WC
UQB24J2WC

ENGLISH

ESPAÑOL

FRANÇAIS

Split-type Air Conditioner (Cooling and Heating)

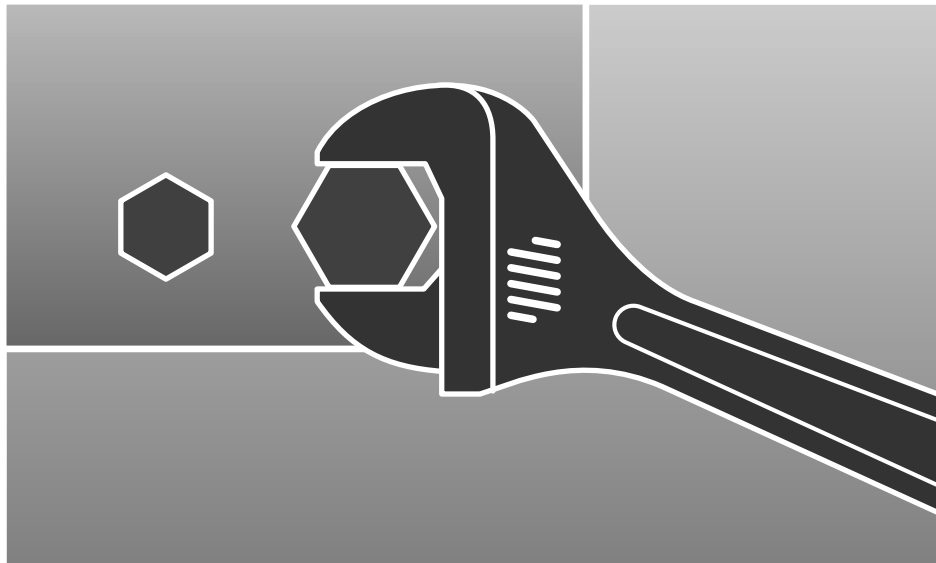

© (S) (F) DB98-25864A(2)



Safety Precautions

You should take the following safety precautions when using your air conditioner.



WARNING

- If you don't follow the safety precautions, you may get the risk of an electric shock, injury or death.
- The manufacturer or qualified service personnel must install this air conditioner.
- Unplug the electric power before repairing, installing or cleaning.

INSTALLING THE AIR CONDITIONER

- ◆ Users should not install the air conditioner by themselves. Ask the dealer or authorized company to install the air conditioner except the window-type air conditioner in U.S.A and Canada.
- ◆ If you don't install the air conditioner properly, it may cause a fire, a water leakage or an electric shock.
- ◆ Install the indoor unit higher than 8.2ft(2.5m) from the floor to avoid the injury caused by the operation of the fan. (except the window-type air conditioner)
- ◆ The manufacturer is not responsible for the accidents or injury caused by an incorrect installation.
- ◆ When installing the built-in type air conditioner, keep all electric cables such as the power cable and the connection cord in pipes, ducts, or cable channels to protect them from the danger of impact or any other incidents.

POWER SUPPLY AND CIRCUIT BREAKER

- ◆ If the power cord of the air conditioner is damaged, it must be replaced by the manufacturer or a qualified person in order to avoid a hazard.
- ◆ The air conditioner must be plugged into an independent circuit if applicable or connect the power cable to the auxiliary circuit breaker. An all pole disconnection from the power supply must be incorporated in the fixed wiring with a contact opening of 0.118inch(3mm).
- ◆ Do not extend an electric cord to the air conditioner.
- ◆ You must install the air conditioner according to the national wiring regulations and safety regulations.

Contents

- ◆ **PREPARING THE INSTALLATION**
 - Deciding the Installation Place 4
 - Accessories 6

- ◆ **INSTALLING THE AIR CONDITIONER**
 - Fixing the Installation Plate 7
 - Purging the Indoor Unit 7
 - Connecting the Assembly Cable 8
 - Installing and Connecting the Drain Hose of the Indoor Unit 9
 - Installing and Connecting the Drain Hose of the Outdoor Unit ... 9
 - Installing and Connecting the Assembly Pipe of the Indoor Unit . 10
 - Cutting or Extending the Pipe 11

- ◆ **COMPLETING THE INSTALLATION**
 - Purging the Connected Pipes 12
 - Performing the Gas Leak Tests 13
 - Fixing the Indoor Unit in Place 13
 - Fixing the Outdoor Unit in Place 14
 - Final Checks and Trial Operation 14
 - Providing Information for User 15

Deciding the Installation Place

You should observe the following restrictions when you decide the installation place.

General

Do NOT install the air conditioner under the following conditions;

- ◆ Combustible gases
- ◆ Saline air
- ◆ Machine oil
- ◆ Sulphide gas
- ◆ Special environmental conditions

If you have no alternative place to install it, first consult your dealer or a qualified person.

Indoor Unit

- ◆ There must be no obstacles near the air inlet and outlet.
- ◆ Install the indoor unit on a surface that can support its weight.
- ◆ Choose a place where you can easily connect the pipes and cables to the outdoor unit.
The recommended length of the pipes and cables is 24.6ft(7.5m). The maximum length is 98.4ft(30m).
- ◆ Leave sufficient space below the indoor unit to remove the filters easily.
- ◆ Maintain sufficient space around the indoor unit as seen in the picture on page 5.
- ◆ Make sure that the water dripping from the drain hose runs off correctly and safely.
- ◆ Install the indoor unit higher than 8.2ft(2.5m) from the ground.

Outdoor Unit

- ◆ NEVER place the outdoor unit on its side or upside down. The compressor lubricating oil may run into the circuit and damage the outdoor unit seriously.
- ◆ Choose a dry and sunny place avoiding direct sunlight or strong winds.
- ◆ Do not obstruct the passage.
- ◆ Avoid a place that may disturb your neighbor. A noise may occur from the outdoor unit and the discharged air may run into the neighborhood.
- ◆ Choose a place where you can easily connect the pipes and cables to the indoor unit.
The recommended length of the pipes and cables is 24.6ft(7.5m). The maximum length is 98.4ft(30m).
- ◆ Install the outdoor unit on a flat and stable surface.
Otherwise it may slant and make some noise and vibration.
- ◆ Install the outdoor unit on a hard and even place that can support its weight.
- ◆ Place the outdoor unit so as to let the discharged air out properly.
- ◆ Maintain sufficient space around the outdoor unit as seen in the picture on page 5.
- ◆ When you install the outdoor unit at a height, you should firmly fix it in its place.
The maximum height is 49ft(15m).
- ◆ Make sure that the water dripping from the drain hose runs off correctly and safely.

CAUTION

- ◆ **The air conditioner must be installed according to the national electrical rules.**
- ◆ **Max input power & current is measured according to IEC standard and input power & current is measured according to ISO standard.**

Observe the clearances and maximum lengths as seen in the picture below when installing the air conditioner.

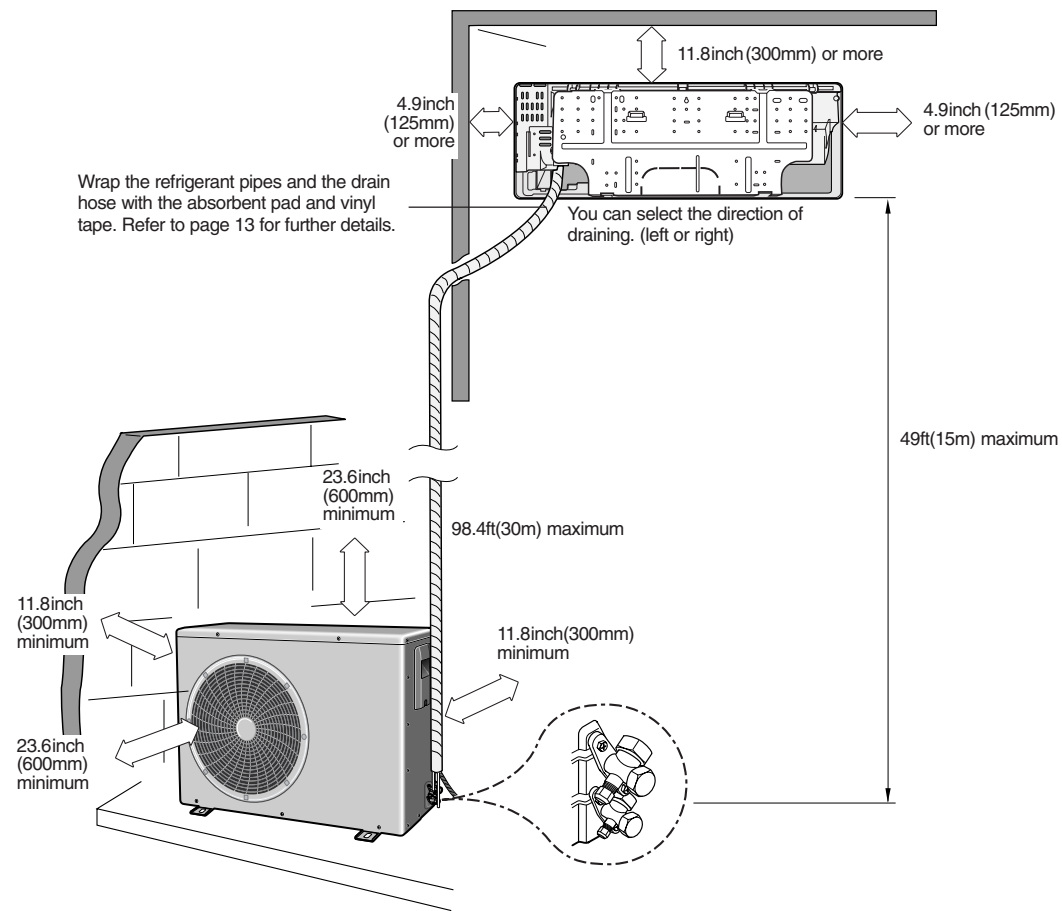

Accessories

The following accessories are supplied with the air conditioner.

- The number of each accessory is indicated in parentheses.

Accessories in the Indoor Unit Case

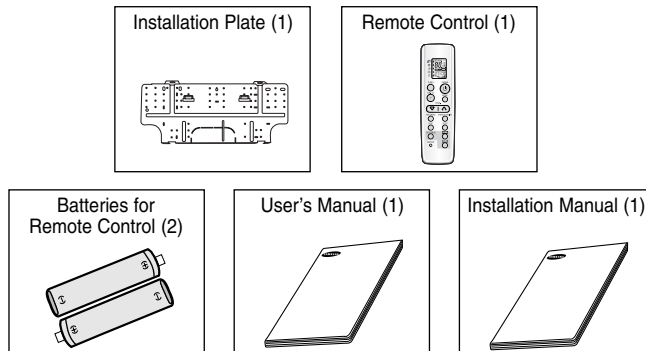

Accessories in the Outdoor Unit Case

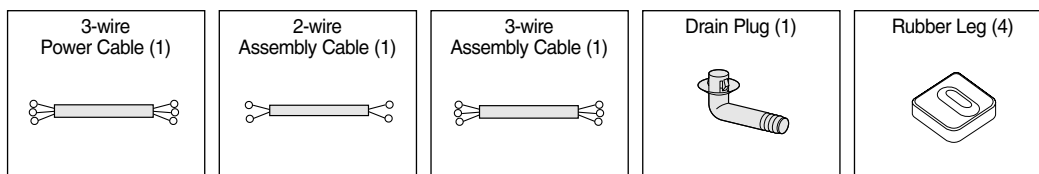

- The flare nuts are attached to the end of each pipe of an evaporator or a service port. Use the nuts when connecting the pipes.
- The (2)3-wire assembly cables are optional. If they are not supplied, use the standard cable.
- The drain plug and rubber leg are only included when the air conditioner is supplied without the assembly pipe as seen in the picture below.

The following connection accessories are optional. If they are not supplied, you should prepare them before installing the air conditioner.

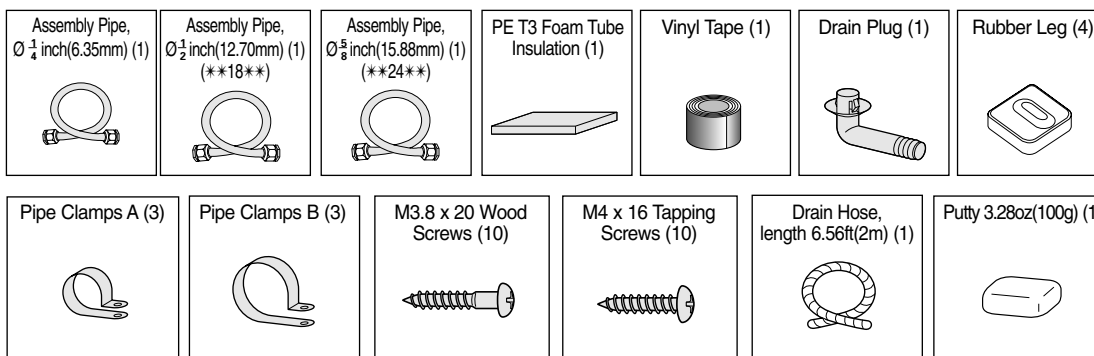

- If these accessories are supplied, you can find them in the accessory box.

Fixing the Installation Plate

Before fixing the installation plate to the wall or window frame, you must determine the position of the $2\frac{3}{16}$ inch(65mm)hole through which the cable, pipe and hose pass to connect the indoor unit to the outdoor unit.

When facing the wall, the pipe and cable can be connected from the:

- ◆ Right
- ◆ Left
- ◆ Underside (right)
- ◆ Rear

1 Determine the position of the pipe and drain hose hole as seen in the picture and drill the hole with an inner diameter of $2\frac{3}{16}$ inch(65mm) so that it slants slightly downwards.

2 If you fix the indoor unit to a...	Follow Steps...
Wall	3.
Window frame	4 to 6.

3 Fix the installation plate to the wall giving attention to the weight of the indoor unit.

- If you mount the plate on the concrete wall with anchor bolts, the anchor bolts must not be projected by more than $\frac{3}{4}$ inch(20mm).

4 Determine the positions of the wooden uprights to be attached to the window frame.

5 Attach the wooden uprights to the window frame giving attention to the weight of the indoor unit.

6 Attach the installation plate to the wooden uprights using tapping screws as seen in the picture.

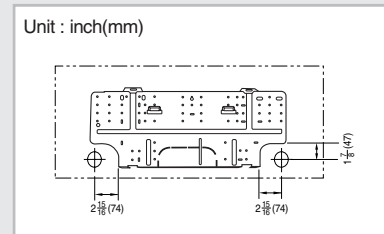
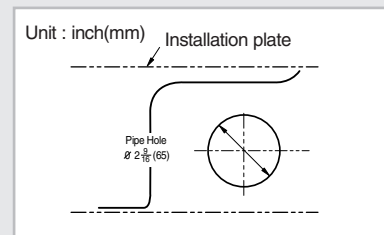
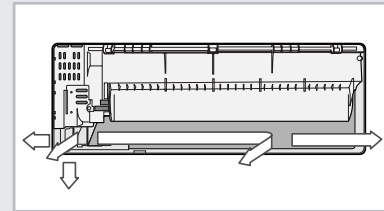

Fixing the Installation Plate

On delivery, there may be inert gas inside the indoor unit. You should purge the gas from the indoor unit before connecting the assembly pipe.

Unscrew the caps at the end of each pipe.

Result: All inert gas exhausts from the indoor unit.

- To prevent dirt or foreign substance from getting into the pipes during installation, do NOT remove the caps completely until you are ready to connect the pipes.

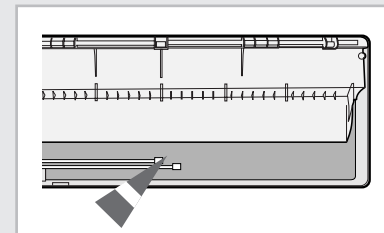

Connecting the Assembly Cable

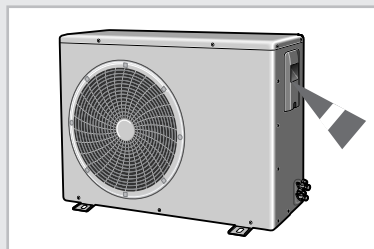
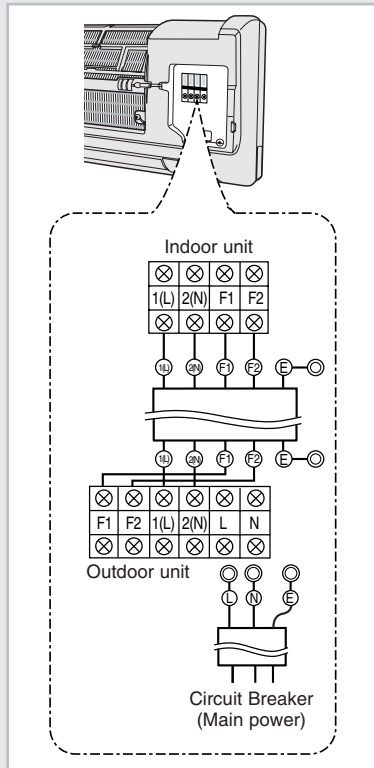

The outdoor unit is powered from the indoor unit through the assembly cable. If the outdoor unit is more than 24.6ft(7.5m) away from the indoor unit, you must extend the cable. The maximum length of the cable is 98.4ft(30m).

- 1 Extend the assembly cable if necessary.
- 2 Open the front grille by pulling on the tabs on the lower right and left sides of the indoor unit.
- 3 Remove the screw securing the connector cover.
- 4 Pass the assembly cable through the rear of the indoor unit and connect the assembly cable to terminals as seen in the picture.
 - > Each wire is labeled with the corresponding terminal number.
- 5 Pass the other end of the cable through the 2 ⁹/₁₆ inch(65mm) hole in the wall.
- 6 Close the connector cover tightening the screw carefully.
- 7 Close the front grille.
- 8 Remove the terminal board cover on the side of the outdoor unit.
- 9 Connect the cables to the terminals as seen in the picture.
 - > Each wire is labeled with the corresponding terminal number.
- 10 Connect the earth conductor to the earth terminals.
- 11 Close the terminal board cover tightening the screw carefully.
- 12 Connect the power cable to the indoor unit.

Power cable specification

Use	AWG	Cross sectional area (mm ²)
Main Power Supply 3-wire power cable	13 or fewer	2.5 or more
Indoor Power Supply 3-wire power cable	16 or fewer	1.5 or more
2-wire assembly cable	16 or fewer	1.5 or more

- > **Connect the power cable to the auxiliary circuit breaker. If every pole fails to connect to the power supply, it must be incorporated in a wire with a contact opening of ≥0.118 inch(3mm).**
- > **The 3-wire power cable and the 2-wire assembly cable are optional. If these cables are not supplied, use the standard cable approved by IEC standard.**

Installing and Connecting the Drain Hose of the Indoor Unit

When installing the drain hose for the indoor unit, you should check if condensate draining is adequate. When you pass the drain hose through the 2⁹/₁₆ inch(65mm) hole drilled in the wall, check the following.

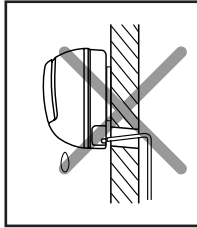

The hose must NOT slant upwards.

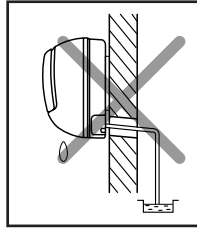

The end of the drain hose must NOT be placed under water.

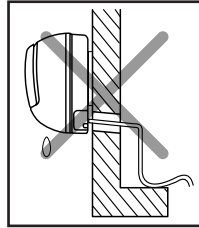

Do NOT bend the hose in different directions.

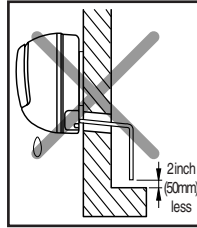

Keep a clearance of at least 2inch(50mm) between the end of the hose and the ground.

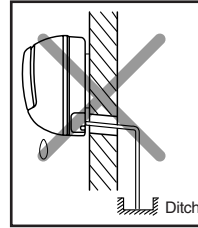

Do NOT place the end of the drain hose in a hollow.

To install the drain hose, do the following.

- 1 If necessary, connect the 6.56ft(2m) extension drain hose to the drain hose.
 - 2 If you use the extension drain hose, insulate the inside of the extension drain hose with a shield.
 - 3 Fit the drain hose into 1 of 2 drain hose holes, and then fix the end of the drain hose with a clamp tightly.
 - > If you don't use the other drain hose hole, block it with a rubber stopper.
 - 4 Pass the drain hose under the refrigerant pipe keeping the drain hose tight.
 - 5 Pass the drain hose through the hole in the wall. Check if it slants downwards as seen in the picture.
- > **The hose will be fixed permanently into position after finishing the installation and the gas leak test; refer to page 12 for further details.**

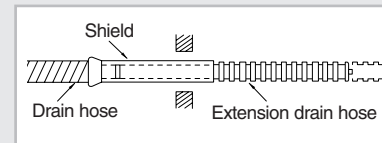

Installing and Connecting the Drain Hose of the Outdoor Unit

While heating, ice may accumulate. During the process of defrosting, you should check if condensate draining is adequate. For the adequate draining, do the following.

- 1 Insert the drain plug into the drain hole on the underside of the outdoor unit.
- 2 Connect the drain hose to the drain plug.
- 3 Ensure that condensate draining is adequate.

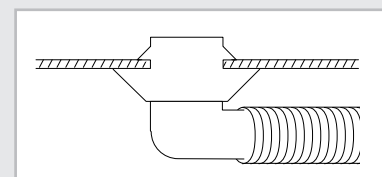
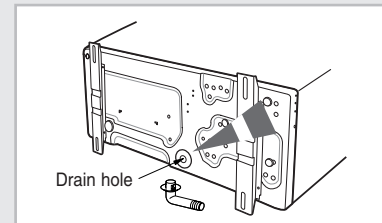

Installing and Connecting the Assembly Pipe of the Indoor Unit

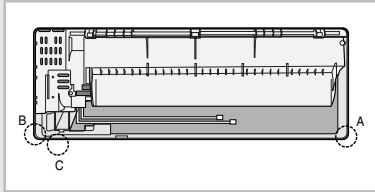

There are 2 refrigerant pipes of different diameters:

- ◆ The smaller one is for the liquid refrigerant
- ◆ The larger one is for the gas refrigerant

A short pipe is already fitted to the air conditioner. You must extend the pipe using the assembly pipe. (Optional)

The connection procedure for the refrigerant pipe varies according to the exit position of the pipe when facing the wall:

- ◆ Right (A)
- ◆ Left (B)
- ◆ Underside (C)
- ◆ Rear

1 Cut out the appropriate knock-out piece on the rear of the indoor unit unless you connect the pipe directly from the rear.

2 Smooth the cut edges.

3 Remove the protection caps of the pipes and connect the assembly pipe to each pipe. Tighten the nuts first with your hands, and then with a torque wrench applying the following torque.

Outer Diameter	Torque
$\frac{1}{4}$ inch(6.35 mm)	10.1~12.3ft•lb(140~170kgf•cm)
$\frac{1}{2}$ inch(12.70 mm)	27.5~30.4ft•lb(380~420kgf•cm)
$\frac{5}{8}$ inch(15.88 mm)	31.8~34.7ft•lb(440~480kgf•cm)

➤ If you want to shorten or extend pipes, refer to page 11.

4 Cut off any excess foam insulation.

5 If necessary, bend the pipe round, along the bottom of the indoor unit and out through the appropriate hole, taking care to ensure that:

- ◆ The piping does not jut out from the rear of the indoor unit
- ◆ The bending radius is 4inch(100mm) or more

6 Pass the piping through the hole in the wall.

7 For further details on how to connect to the outdoor unit and purge the air, refer to page 12.

➤ **The pipe will be insulated and fixed permanently into position after finishing the installation and the gas leak test; refer to page 13 for further details.**

Cutting or Extending the Pipe

A 24.6ft(7.5m) pipe is supplied with the air conditioner. (Optional)

The length of the pipe can be:

- ◆ Extended up to 98.4ft(30m)
- ◆ Shortened as required
- ✦ If you need a pipe longer than 24.6ft(7.5m):
 - ◆ You must extend the assembly cable.
 - ◆ You must add refrigerant to the pipes; otherwise, the indoor unit may freeze.

1 Make sure that you prepared the required tools. (pipe cutter, reamer, flaring tool and pipe holder)

2 If you want to shorten the pipe, cut it using a pipe cutter ensuring that the cut edge remains at 90° with the side of the pipe. There are some examples of correctly and incorrectly cut edges below.

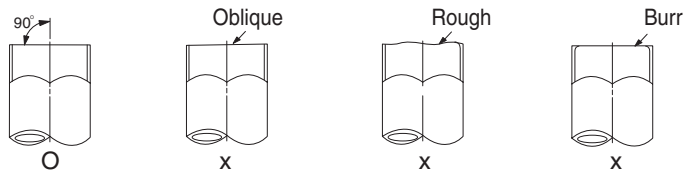

3 To prevent a gas leak, remove all burrs at the cut edge of the pipe using a reamer.

4 Put a flare nut slightly into the pipe and modify the flare.

Outer Diameter (D)	Depth (A)
$\frac{1}{4}$ inch(6.35 mm)	$\frac{1}{16}$ inch(1.3 mm)
$\frac{1}{2}$ inch(12.70 mm)	$\frac{1}{16}$ inch(2.0 mm)
$\frac{5}{8}$ inch(15.88 mm)	$\frac{1}{8}$ inch(2.2 mm)

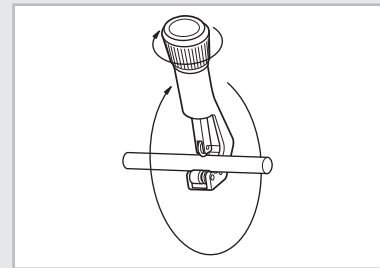

5 Check if you flared the pipe correctly. There are some examples of incorrectly flared pipes below.

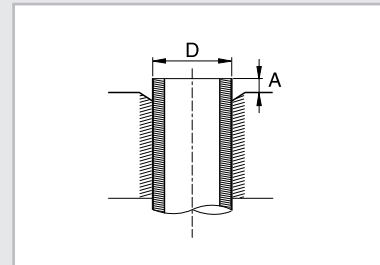
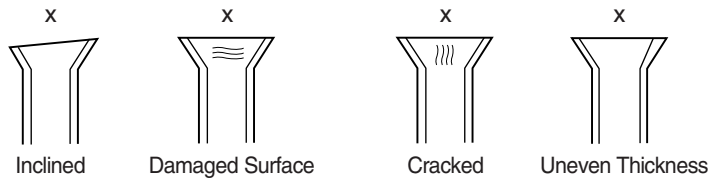

6 Align the pipes to connect them easily. Tighten the flare nuts first with your hands, and then with a torque wrench applying the following torque.

Outer Diameter	Torque
$\frac{1}{4}$ inch(6.35 mm)	10.1~12.3ft•lb(140~170kgf•cm)
$\frac{1}{2}$ inch(12.70 mm)	27.5~30.4ft•lb(380~420kgf•cm)
$\frac{5}{8}$ inch(15.88 mm)	31.8~34.7ft•lb(440~480kgf•cm)

7 For further details on how to connect to the outdoor unit and purge the air, refer to page 12.

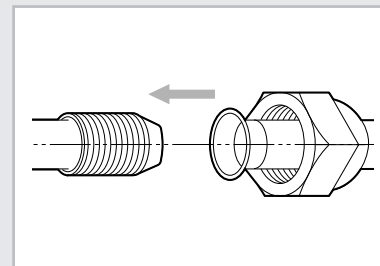

Purging the Connected Pipes

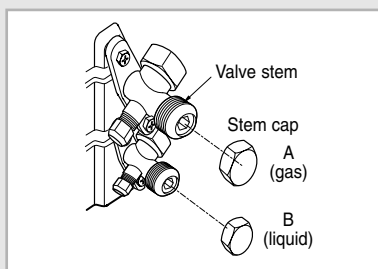
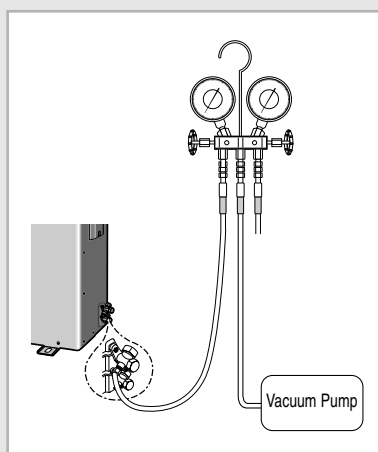
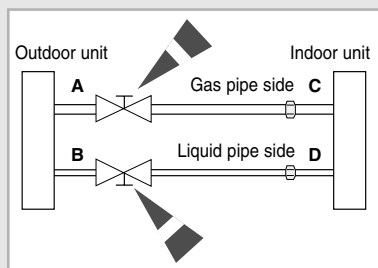

The outdoor unit is loaded with sufficient R410A refrigerant for a 24.6ft(7.5m) pipe. You should purge the air in the indoor unit and in the pipe. If air remains in the refrigerant pipes, it affects the compressor. It may cause reduction of cooling and heating capacity and malfunction. Refrigerant for air purging is not charged in the outdoor unit. Use Vacuum Pump as seen in the picture.

- 1 Connect each assembly pipe to the appropriate valve on the outdoor unit and tighten the flare nut.
- 2 Tighten the flare nut first with your hands, and then with a torque wrench applying the following torque.

Outer Diameter	Torque
$\frac{1}{4}$ inch(6.35 mm)	10.1~12.3ft•lb(140~170kgf•cm)
$\frac{1}{2}$ inch(12.70 mm)	27.5~30.4ft•lb(380~420kgf•cm)
$\frac{5}{8}$ inch(15.88 mm)	31.8~34.7ft•lb(440~480kgf•cm)

- 3 Connect the charging hose of low-pressure side of manifold gauge to a gas service port as seen in the picture.
- 4 Open the valve of the low pressure side of manifold gauge counterclockwise.
- 5 Purge the air in the connected pipes using vacuum pump for about 10 minutes.
 - Close the valve of the low pressure side of manifold gauge clockwise.
 - Make sure that pressure gauge show -0.1MPa(-76cmHg) after about 10 minutes.
 - This procedure is very important to avoid a gas leak.
 - Turn off the vacuum pump.
 - Remove the hose of the low pressure side of manifold gauge.
- 6 Set a valve cork of liquid and gas service port to the open position.
- 7 Mount the valve stem nuts and the service port cap to the valve, and tighten them at the torque of 183kgf•cm with a torque wrench.
- 8 Check for a gas leak.
 - At this time, especially check for a gas leak from the 3-way valve's stem nuts and from the service port cap.

Adding Refrigerant

If you have used more than 24.6ft(7.5m), add "Q" of refrigerant for extra feet.

Model	"Q" (R410A)/ft
18	0.21oz(6.1g)/ft
24	0.16oz(4.6g)/ft

Refer to the Service Manual for further details.

Performing the Gas Leak Tests

You must check if there is a gas leak before completing all the installation process. (connecting the assembly pipe and hose between indoor unit and outdoor unit, insulating the cables, hose and pipe, and fixing the indoor unit to the installation plate)

To check for gas leaks on the...	Using a leak detector, check the...
Indoor unit	Flare nuts at the end of sections C and D.
Outdoor unit	Valves on sections A and B.

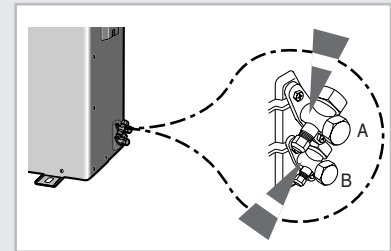
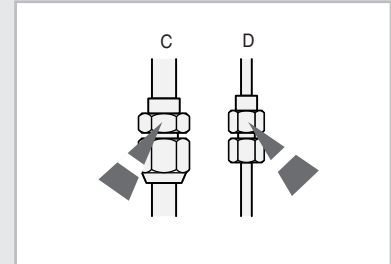

Fixing the Indoor Unit in Place

After checking for a gas leak in the system, you can insulate the pipe, hose and cables. Then place the indoor unit on the installation plate.

- To avoid condensation problems, place heat-resistant polyethylene foam separately around each refrigerant pipe in the lower part of the indoor unit.
- Wrap the refrigerant pipe and the drain hose in the rear of the indoor unit with the absorbent pad.
 - Wind the pipe and hose three times to the end of the indoor unit with the absorbent pad. [$\frac{3}{4}$ inch(20mm) interval]
- Wind the pipe, assembly cable and drain hose with insulation tape.
- Place the bundle (the pipe, assembly cable and drain hose) in the lower part of the indoor unit carefully so as not to be projected from the rear of the indoor unit.
- Hook the indoor unit on the installation plate and move the unit to the right and left until it secures in place.
- Wrap the rest of the pipe with vinyl tape.
- Attach the pipe to the wall using clamps (Optional).

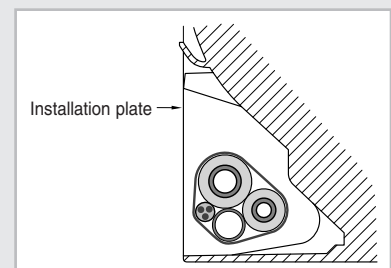
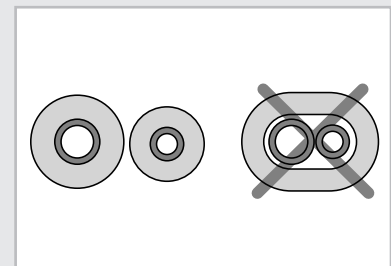

Fixing the Outdoor Unit in Place

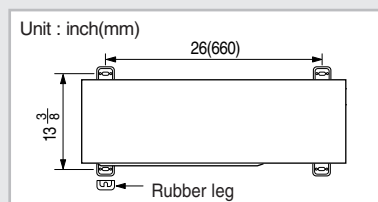

You should install the outdoor unit on a stable base to avoid the generation of noise and vibration, especially when installing the outdoor unit close to your neighbor.

If you install the outdoor unit in a place exposed to strong winds or at a height, you must fix it to the appropriate support (wall or ground).

- 1 Place the outdoor unit as indicated on the top of the unit to let the discharged air out properly.
- 2 Fix the outdoor unit to the appropriate support using anchor bolts.
- 3 If the outdoor unit is exposed to strong winds, install shield plates around the outdoor unit, so that the fan can operate correctly.

➤ **Secure the rubber leg in order to prevent the generation of noise and vibration.**

Final Checks and Trial Operation

To complete the installation, perform the following checks and tests to ensure that the air conditioner operates correctly.

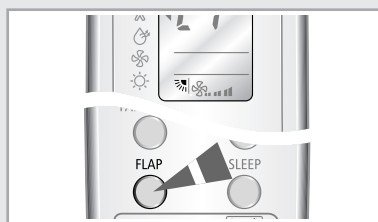

- 1 Check the following.
 - ◆ Strength of the installation site
 - ◆ Tightness of pipe connection to detect a gas leak
 - ◆ Electric wiring connection
 - ◆ Heat-resistant insulation of the pipe
 - ◆ Drainage
 - ◆ Earth conductor connection
 - ◆ Correct operation (follow the steps below)
- 2 Press the  button for 5 seconds. Or press the K1 switch of the display board twice(Cooling test operation) or 3 times(Heating test operation) after removing the side cover of the outdoor unit.
 - ◆ The LED of the indoor unit displays the option code.
 - ◆ The airflow blade swings up and down and the indoor fan operates.

Providing Information for User

After finishing the installation of the air conditioner, you should explain the following to the user. Refer to appropriate pages in the User's Manual.

1 How to start and stop the air conditioner

2 How to select the modes and functions

3 How to adjust the temperature and fan speed

4 How to adjust the airflow direction

5 How to set the timers

6 How to clean and replace the filters

> **When you complete the installation successfully, hand over the User's Manual and this Installation Manual to the user for storage in a handy and safe place.**

